



SUPPORT YOUR IMAGE

Contact Information

NINGBO EIMAGE STUDIO EQUIPMENT CO., LTD

Address: No.373 South Hangyong Rd, Luotuo Industry zone, Zhenhai,
Ningbo, China. 315202

Tel:86-574-86590061,86-574-86590031

Fax:0574-86590078

E-mail: sales@eimagevideo.com

Visit www.eimagevideo.com for more information



E-IMAGE Official QR Code



The magic life in the image world

E-IMAGE



2017/18

CAMERA SUPPORT

www.eimagevideo.com



Ningbo Eimage Studio Equipment Co.,Ltd. is a leading manufacturer which is specializing in providing Fluid video heads and Professional video tripods, camera bags and accessories. Basing on the growing demands of video and broadcasting market and the dedicated research in the video tripod and bag filed, the company now becomes a well recognized brand in this field around the world.Choose E-IMAGE, it will bring you a safety guarantee and optimum operating enjoyment with smaller budget in the image world.

Contents	1	FLUID HEADS
	13	VIDEO TRIPODS
	27	HEAD & TRIPODS SYSTEMS
	47	ACCESSORIES
	55	KEY TO SYMBOLS

GH03F



- Flat base
- 5kg
- Installed



Fixed fluid on pan and tilt



Parking hole for hydrostatic arm with 1/4" or 3/8" threads



Quick-action attachment & release with only one press

RECOMMENDED ACCESSORIES



Long plate 360mm P8



Long plate 220mm P9



75mm bowl to flat adapter 75BF



Universal support system MK35

SPECIFICATIONS

	Payload range	5.0kg / 11.0lbs
	Net weight	1.2kg / 2.6lbs
	Counterbalance	Installed
	Grades of pan drag	Fixed

	Grades of tilt drag	Variable
	Tilt range	-60°/+90°
	Temperature range	-40°C/+80°C
	Bowl size	Flat base

COUNTERBALANCE GRAPH

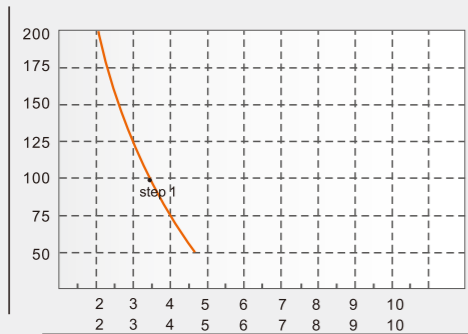

Balance Chart

Total Load Kg

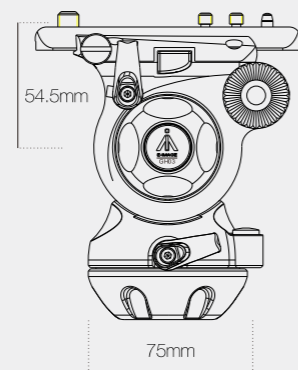

ACCESSORIES
▶ Pages 47-54

SYSTEMS
▶ Pages 27-46

GH03



- 75mm
- 5kg
- Installed



Fixed fluid on pan and tilt



Parking hole for hydrostatic arm with 1/4" or 3/8" threads



Quick-action attachment & release with only one press

RECOMMENDED ACCESSORIES



Long plate 360mm P8



Long plate 220mm P9



Bowl adapter 100/75mm EI-A17



Clamping screw 75L



Universal support system MK35

SPECIFICATIONS

	Payload range	5.0kg / 11.0lbs
	Net weight	1.3kg / 2.9lbs
	Counterbalance	Installed
	Grades of pan drag	Fixed

	Grades of tilt drag	Variable
	Tilt range	-60°/+90°
	Temperature range	-40°C/+80°C
	Bowl size	75mm

COUNTERBALANCE GRAPH

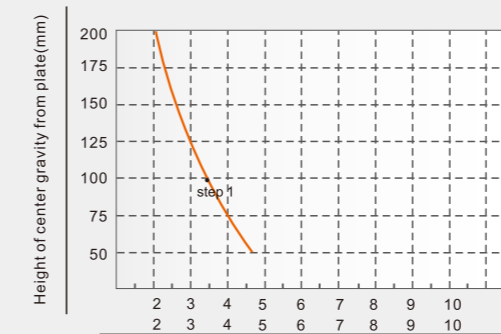

Balance Chart

Total Load Kg

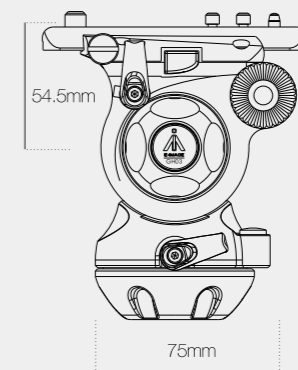

ACCESSORIES
▶ Pages 47-54

SYSTEMS
▶ Pages 27-46

GH04

NEW



- Flat base / 75mm
- 6kg
- Installed



Fixed drag on both pan and tilt



Parking hole for hydrostatic arm with 1/4" or 3/8" threads



Quick-action attachment & release with only one press



Leveling bubble

RECOMMENDED ACCESSORIES



Long plate 360mm P8



Long plate 220mm P9



Bowl adapter 100/75mm EI-A17



Clamping screw 75L



Universal support system MK35

SPECIFICATIONS

	Payload range	6.0kg / 13.2lbs
	Net weight	1.5kg / 3.3lbs
	Counterbalance	Installed
	Grades of pan drag	Fixed

	Grades of tilt drag	Fixed
	Tilt range	-70°/+90°
	Temperature range	-40°C/+80°C
	Bowl size	75mm

COUNTERBALANCE GRAPH

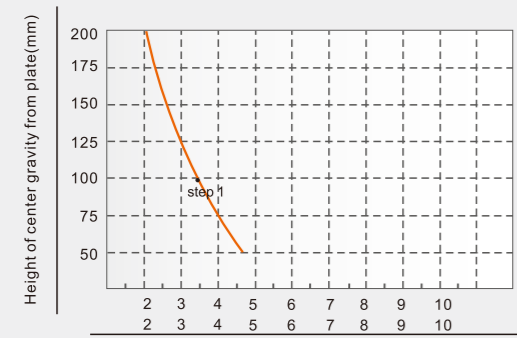

Balance Chart

Total Load Kg

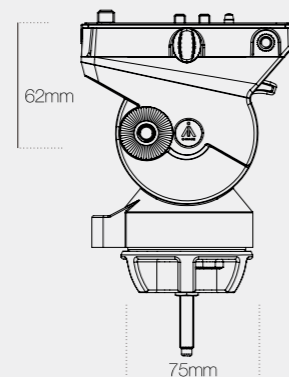

ACCESSORIES
▶ Pages 47-54

SYSTEMS
▶ Pages 27-46

GH06



- 75mm
- 6kg
- 0-5



0-3 grades of pan & tilt drag adjustment



Parking hole for hydrostatic arm with 1/4" or 3/8" threads



Quick-action attachment & release with only one press



Multi-adjustment(0-5) counterbalance can reach perfect balance quickly and easily

RECOMMENDED ACCESSORIES



Long plate 360mm P8



Long plate 220mm P9



Bowl adapter 100/75mm EI-A17



Clamping screw 75L



Camcorder Adapter PS-C



Universal support system MK35

SPECIFICATIONS

	Payload range	6.0kg / 13.2lbs
	Net weight	2.0kg / 4.4lbs
	Counterbalance	0-5
	Grades of pan drag	0-3

	Grades of tilt drag	0-3
	Tilt range	-60°/+90°
	Temperature range	-40°C/+80°C
	Bowl size	75mm

COUNTERBALANCE GRAPH

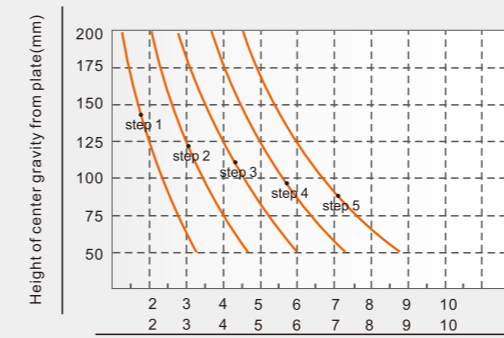

Balance Chart

Total Load Kg

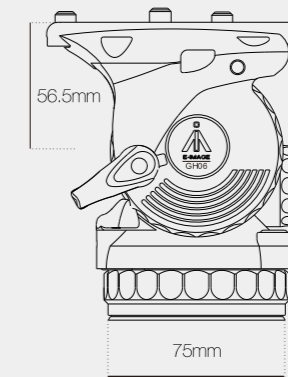

ACCESSORIES
▶ Pages 47-54

SYSTEMS
▶ Pages 27-46

GH08



- 75mm
- 8kg
- 1-7



Installed fluid on pan and tilt.



Parking hole for hydrostatic arm with 1/4" or 3/8" threads



Illuminated leveling bubble



Multi-adjustment(1-7) counterbalance can reach perfect balance quickly and easily

RECOMMENDED ACCESSORIES



Long plate 220 / 360mm P9 / P8 Bowl adapter 100/75mm EI-A17 Telescopic left pan bar GB2 Clamping screw 75L Camcorder Adapter PS-C Universal support system MK35

SPECIFICATIONS

	Payload range	8.0kg / 17.6lbs		Grades of tilt drag	Installed
	Net weight	2.0kg / 4.4lbs		Tilt range	-60°/+90°
	Counterbalance	1-7		Temperature range	-40°C/+80°C
	Grades of pan drag	Installed		Bowl size	75mm

COUNTERBALANCE GRAPH

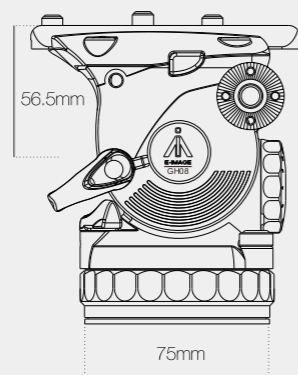
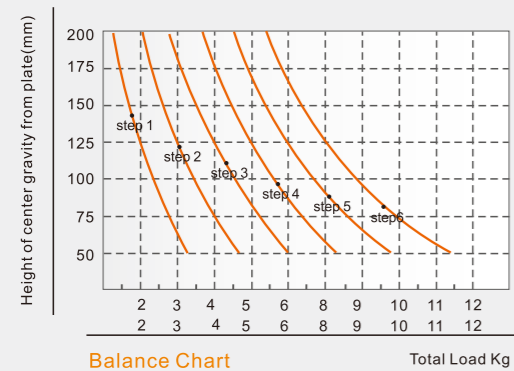

ACCESSORIES
▶ Pages 47-54
SYSTEMS
▶ Pages 27-46

GH10



- 75mm
- 10kg
- 1-7



0-3 grades of pan & tilt drag adjustment



Parking hole for hydrostatic arm with 1/4" or 3/8" threads



Illuminated leveling bubble



Multi-adjustment(1-7) counterbalance can reach perfect balance quickly and easily

RECOMMENDED ACCESSORIES

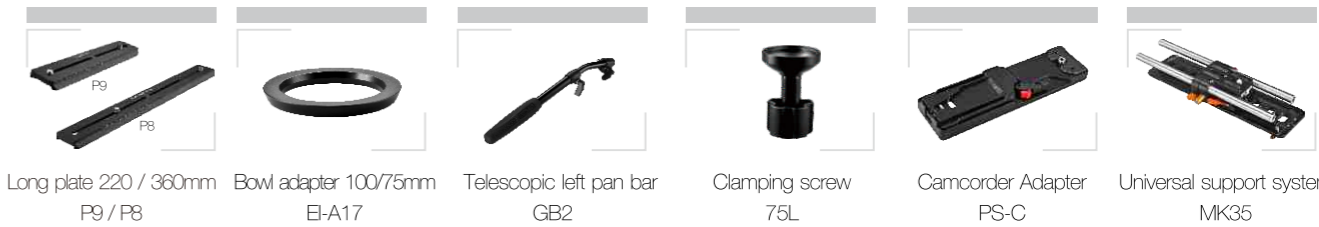

Long plate 220 / 360mm P9 / P8 Bowl adapter 100/75mm EI-A17 Telescopic left pan bar GB2 Clamping screw 75L Camcorder Adapter PS-C Universal support system MK35

SPECIFICATIONS

	Payload range	10.0kg / 22.0lbs		Grades of tilt drag	0-3
	Net weight	2.2kg / 4.9lbs		Tilt range	-60°/+90°
	Counterbalance	1-7		Temperature range	-40°C/+80°C
	Grades of pan drag	0-3		Bowl size	75mm

COUNTERBALANCE GRAPH

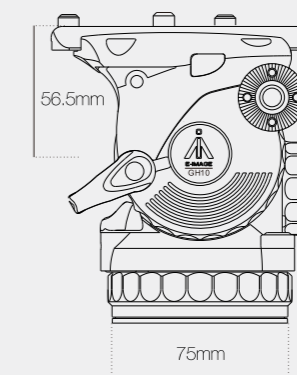
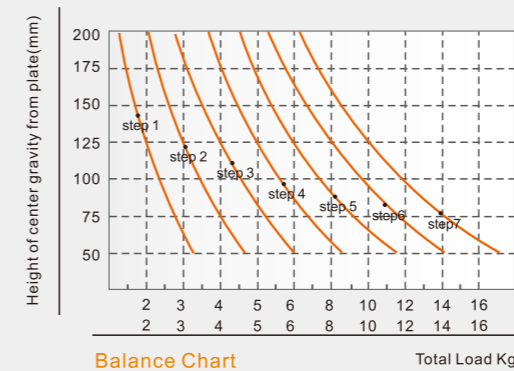

ACCESSORIES
▶ Pages 47-54
SYSTEMS
▶ Pages 27-46

GH08L



- 100mm
- 8kg
- 1-7



Installed fluid on pan and tilt.

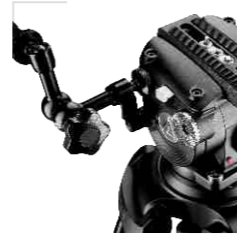

Parking hole for hydrostatic arm with 1/4" or 3/8" threads



Illuminated leveling bubble



Multi-adjustment(1-7) counterbalance can reach perfect balance quickly and easily

RECOMMENDED ACCESSORIES



SPECIFICATIONS

	Payload range	8.0kg / 17.6lbs
	Net weight	2.3kg / 5.1lbs
	Counterbalance	1-7
	Grades of pan drag	Installed

	Grades of tilt drag	Installed
	Tilt range	-60°/+90°
	Temperature range	-40°C/+80°C
	Bowl size	100mm

COUNTERBALANCE GRAPH

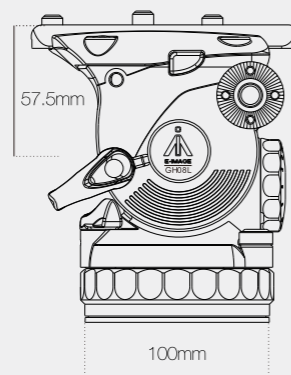
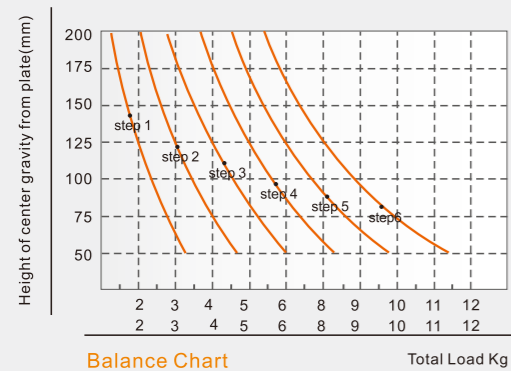

ACCESSORIES
▶ Pages 47-54

SYSTEMS
▶ Pages 27-46

GH10L



- 100mm
- 10kg
- 1-7



0-3 grades of pan & tilt drag adjustment



Parking hole for hydrostatic arm with 1/4" or 3/8" threads



Illuminated leveling bubble



Multi-adjustment(1-7) counterbalance can reach perfect balance quickly and easily

RECOMMENDED ACCESSORIES



SPECIFICATIONS

	Payload range	10.0kg / 22.0lbs
	Net weight	2.5kg / 5.5lbs
	Counterbalance	1-7
	Grades of pan drag	0-3

	Grades of tilt drag	0-3
	Tilt range	-60°/+90°
	Temperature range	-40°C/+80°C
	Bowl size	100mm

COUNTERBALANCE GRAPH

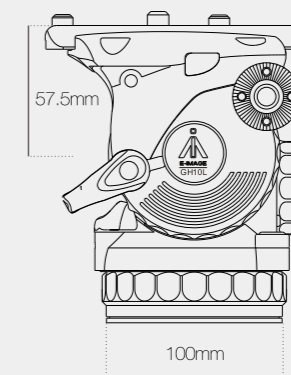
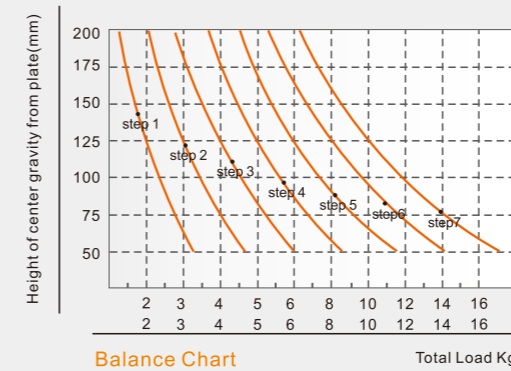

ACCESSORIES
▶ Pages 47-54

SYSTEMS
▶ Pages 27-46

GH15



- 100mm
- 15kg
- 0-9



0-5 grades of pan & tilt drag adjustment



Parking hole for hydrostatic arm with 1/4" or 3/8" threads



Illuminated leveling bubble



Multi-adjustment(0-9) counterbalance can reach perfect balance quickly and easily

RECOMMENDED ACCESSORIES



Bowl adapter 150/100mm
EI-A18



100mm bowl riser
EI-A19



Telescopic left pan bar
GB3



Camcorder Adapter
PS-C



Universal support system
MK35

SPECIFICATIONS

	Payload range	15.0kg / 33.0lbs
	Net weight	3.8kg / 8.4lbs
	Counterbalance	0-9
	Grades of pan drag	0-5

	Grades of tilt drag	0-5
	Tilt range	-75°/+90°
	Temperature range	-40°C/+80°C
	Bowl size	100mm

COUNTERBALANCE GRAPH

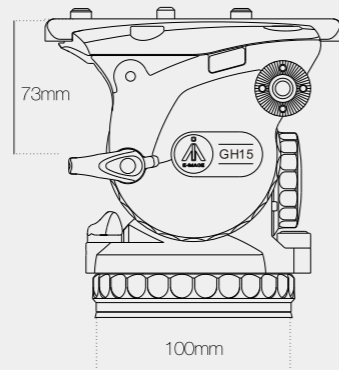
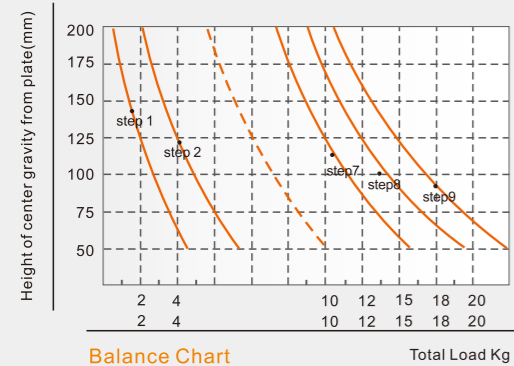

ACCESSORIES
▶ Pages 47-54

SYSTEMS
▶ Pages 27-46

GH25



- 100mm
- 25kg
- 1-15



0-7 grades of pan & tilt drag adjustment



Parking hole for hydrostatic arm with 1/4" or 3/8" threads



Illuminated leveling bubble



Multi-adjustment(1-15) counterbalance can reach perfect balance quickly and easily

RECOMMENDED ACCESSORIES



Bowl adapter 150/100mm
EI-A18



100mm bowl riser
EI-A19



Telescopic left pan bar
GB3



Camcorder Adapter
PS-C



Universal support system
MK35

SPECIFICATIONS

	Payload range	25.0kg / 55.0lbs
	Net weight	4.2kg / 9.2lbs
	Counterbalance	1-15
	Grades of pan drag	0-7

	Grades of tilt drag	0-7
	Tilt range	-80°/+90°
	Temperature range	-40°C/+80°C
	Bowl size	100mm

COUNTERBALANCE GRAPH

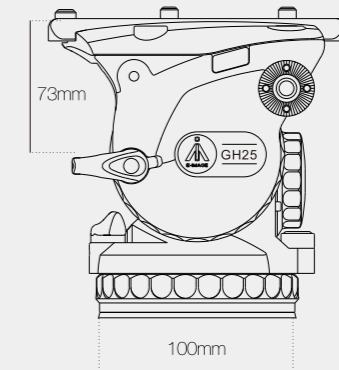
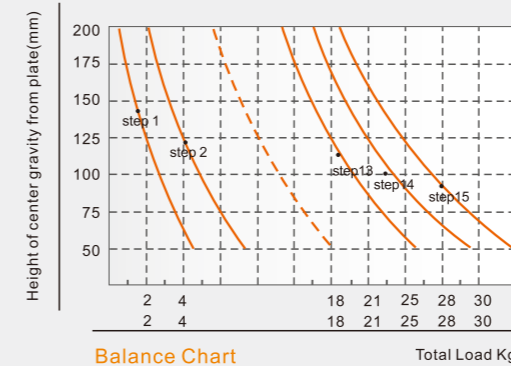

ACCESSORIES
▶ Pages 47-54

SYSTEMS
▶ Pages 27-46

GH20



- 100mm
- 20kg
- 0-8



Installed fluid on pan and tilt



Level bubble



Multi-adjustment(0-8) counterbalance can reach perfect balance quickly and easily

RECOMMENDED ACCESSORIES



Bowl adapter 150/100mm
EI-A18



100mm bowl riser
EI-A19



Telescopic left pan bar
HD7081



Camcorder Adapter
PS-C



Universal support system
MK35

SPECIFICATIONS

	Payload range	20.0kg / 44.0lbs
	Net weight	3.5kg / 7.7lbs
	Counterbalance	0-8
	Grades of pan drag	Installed

	Grades of tilt drag	Installed
	Tilt range	-60°/+90°
	Temperature range	-30°C/+60°C
	Bowl size	100mm

COUNTERBALANCE GRAPH

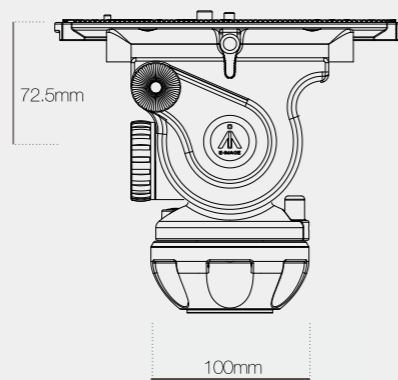
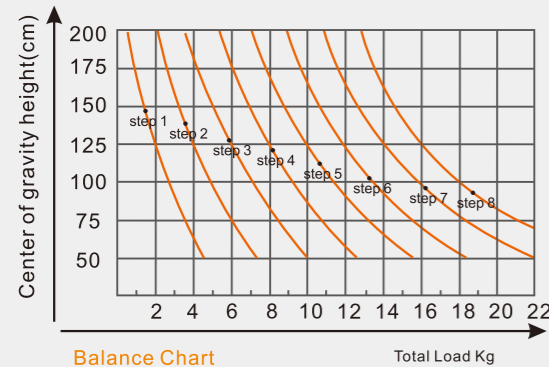

ACCESSORIES
▶ Pages 47-54

SYSTEMS
▶ Pages 27-46

UPGRADE VERSION

GH40 PLUS



- 150mm
- 40kg
- 1-9



0-11 grades of pan & tilt drag adjustment



Parking hole for hydrostatic arm with 1/4" or 3/8" threads



9 counterbalance steps + boost orange button can reach perfect balance quickly and easily



Switch dial knob for different payload

RECOMMENDED ACCESSORIES



Camcorder Adapter
PS-C

SPECIFICATIONS

	Payload range	40.0kg / 88.0lbs
	Net weight	8.8kg / 19.4lbs
	Counterbalance	1-9
	Grades of pan drag	0-11

	Grades of tilt drag	0-11
	Tilt range	-90°/+90°
	Temperature range	-40°C/+80°C
	Bowl size	150mm

COUNTERBALANCE GRAPH

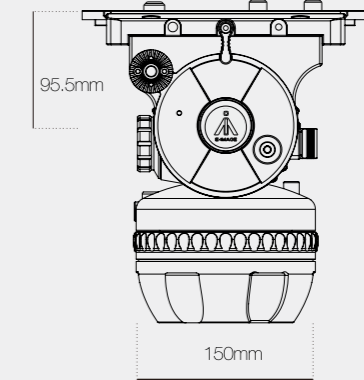
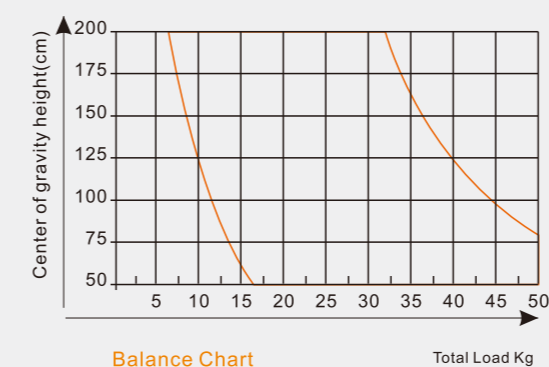

ACCESSORIES
▶ Pages 47-54

SYSTEMS
▶ Pages 27-46

E-IMAGE Video Tripods

E-IMAGE provides all kinds of tripod legs, from 75mm, 100mm to 150mm, aluminum or carbon fiber materials are all available, and also 1 stage or 2 stages. They are extremely stable, sturdy. The tripods feature quick-locking patent structure, which provides quick and smooth operation. They are with high stability due to double-extension tubes.



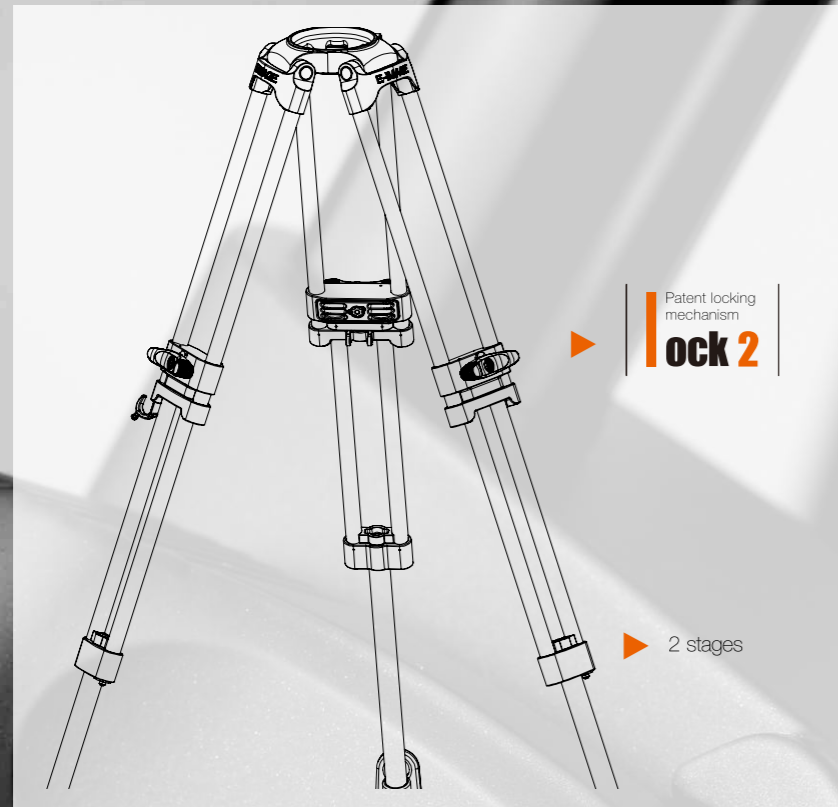

Patent locking mechanism

For GA752 / GC752 / GA102 / GC102



GA752 / GC752



▶ GA752

-  75mm
-  Aluminum
-  3

Patent locking mechanism
Lock 2



▶ GC752

-  75mm
-  Carbon fiber
-  3

Patent locking mechanism
Lock 2



ACCESSORIES
▶ Pages 47-54

SYSTEMS
▶ Pages 27-46

RECOMMENDED ACCESSORIES



Ground spreader
GS02



75mm bowl to flat adapter
75BF



Dolly
E17003 / E17004 / E17004B / E17004C

SPECIFICATIONS

GA752

	Payload	40.0kg / 88.0lbs
	Height range	63.5cm~157.0cm/25.0-61.8in
	Transport length	72cm / 28.3in
	Net weight	3.6kg / 8.0lbs

	Bowl size	75mm
	Sections	3
	Material	Aluminum

GC752



	Payload	40.0kg / 88.0lbs
	Height range	63.5cm~157.0cm/25.0-61.8in
	Transport length	72cm / 28.3in
	Net weight	3.2kg / 7.1lbs

	Bowl size	75mm
	Sections	3
	Material	Carbon fiber

GA752S

NEW

▶ GA752S

-  75mm
-  Aluminum
-  3



LIGHTER WEIGHT
Only **2.6kg**



RECOMMENDED ACCESSORIES

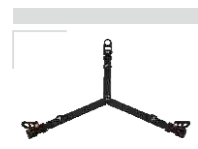

Ground spreader
GS02









75mm bowl to flat adapter
75BF



Dolly
E17003 / E17004 / E17004B / E17004C



SPECIFICATIONS

GA752S

	Payload	30.0kg / 66.0lbs		Bowl size	75mm
	Height range	64.0cm~156.0cm/25.2-61.4in		Sections	3
	Transport length	74.0cm / 29.1in		Material	Aluminum
	Net weight	2.6kg / 5.7lbs			



GA751 / GC751

▶ GA751

-  75mm
-  Aluminum
-  2



▶ GC751

-  75mm
-  Carbon fiber
-  2



ACCESSORIES
▶ Pages 47-54

SYSTEMS
▶ Pages 27-46

RECOMMENDED ACCESSORIES



Ground spreader
GS02









75mm bowl to flat adapter
75BF



Dolly
E17003 / E17004 / E17004B / E17004C

SPECIFICATIONS

GA751



	Payload	40.0kg / 88.0lbs		Bowl size	75mm
	Height range	76.0cm~138.5cm/26.4-54.5in		Sections	2
	Transport length	83cm / 32.7in		Material	Aluminum
	Net weight	3.0kg / 6.6lbs			

GC751

	Payload	40.0kg / 88.0lbs		Bowl size	75mm
	Height range	76.0cm~138.5cm/26.4-54.5in		Sections	2
	Transport length	83cm / 32.7in		Material	Carbon fiber
	Net weight	2.7kg / 5.9lbs			

GA102 / GC102



▶ GA102

-  100mm
-  Aluminum
-  3

Patent locking mechanism
lock 2



▶ GC102

-  100mm
-  Carbon fiber
-  3

Patent locking mechanism
lock 2



RECOMMENDED ACCESSORIES



SPECIFICATIONS

GA102



	Payload	60.0kg / 132.0lbs		Bowl size	100mm
	Height range	47.0cm~160.0cm / 18.5in~63.0in		Sections	3
	Transport length	74.0cm / 29.1in		Material	Aluminum
	Net weight	5.1kg / 11.2lbs			

GC102

	Payload	60.0kg / 132.0lbs		Bowl size	100mm
	Height range	47.0cm~160.0cm / 18.5in~63.0in		Sections	3
	Transport length	74.0cm / 29.1in		Material	Carbon fiber
	Net weight	4.4kg / 9.7lbs			



GA101 / GC101

▶ GA101

-  100mm
-  Aluminum
-  2



▶ GC101

-  100mm
-  Carbon fiber
-  2









RECOMMENDED ACCESSORIES









SPECIFICATIONS

GA101

	Payload	60.0kg / 132.0lbs		Bowl size	100mm
	Height range	63.5cm~140.5cm/25.0-55.3in		Sections	2
	Transport length	85.0cm / 33.5in		Material	Aluminum
	Net weight	4.5kg / 9.9lbs			

GC101



	Payload	60.0kg / 132.0lbs		Bowl size	100mm
	Height range	63.5cm~140.5cm/25.0-55.3in		Sections	2
	Transport length	85.0cm / 33.5in		Material	Carbon fiber
	Net weight	3.9kg / 8.6lbs			

ACCESSORIES
▶ Pages 47-54

SYSTEMS
▶ Pages 27-46



AT7402A / AT7602A

▶ AT7402A

-  75mm
-  Aluminum
-  3



▶ AT7602A

-  100mm
-  Aluminum
-  3



RECOMMENDED ACCESSORIES

AT7402A



75mm bowl to flat adapter
75BF

AT7602A



Middle spreader
GS01



Rubber feet
F3



100mm bowl to flat adapter
100BF









Dolly
E17004 / 04B / 04C /
05 / 05B / 06

ACCESSORIES
▶ Pages 47-54





SYSTEMS
▶ Pages 27-46

SPECIFICATIONS

AT7402A

	Payload	40.0kg / 88.0lbs		Bowl size	75mm
	Height range	66.0cm~149.0cm/26.0~58.7in		Sections	3
	Transport length	70.0cm / 27.6in		Material	Aluminum
	Net weight	3.6kg / 7.9lbs			



AT7602A

	Payload	60.0kg / 132.0lbs		Bowl size	100mm
	Height range	40.0cm~155.0cm/15.7~61.0in		Sections	3
	Transport length	72.0cm / 28.3in		Material	Aluminum
	Net weight	4.2kg / 9.3lbs			

ECT100M / ECT100L

NEW



▶ ECT100M

-  100mm
-  Carbon fiber
-  3



NEW

▶ ECT100L

-  100mm
-  Carbon fiber
-  2









SPECIFICATIONS

ECT100M

	Payload	100kg / 220.0lbs		Bowl size	100mm
	Height range	55.5cm~151.5cm / 21.9in~59.6in		Net weight	8.5kg / 18.7lbs
	Transport length	74.5cm / 29.3in		Material	Carbon fiber



ECT100L

	Payload	100.0kg / 220.0lbs		Bowl size	100mm
	Height range	75.5cm~151.5cm / 29.7in~59.6in		Net weight	8.1kg / 17.9lbs
	Transport length	92.5cm / 36.4in		Material	Carbon fiber

TRIPODS



760AT / 770AT / 760CT / 770CT

▶ 760AT/770AT

-  75mm/100mm
-  Aluminum
-  3



▶ 760CT/770CT

-  75mm/100mm
-  Carbon fiber
-  3



RECOMMENDED ACCESSORIES





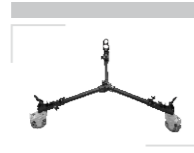



Stone bag
ST-1



Dolly
E17004C

SPECIFICATIONS

Model						
760AT	20.0kg / 44.0lbs	13.0cm~130.0cm / 5.1in~51.2in	60.0cm / 23.6in	2.6kg / 5.7lbs	75mm	Aluminum
770AT	25.0kg / 55.0lbs	20.0cm~140.0cm / 7.9in~55.1in	65.0cm / 25.6in	3.2kg / 7.0lbs	100mm	Aluminum
760CT	20.0kg / 44.0lbs	13.0cm~130.0cm / 5.1in~51.2in	60.0cm / 23.6in	2.2kg / 4.8lbs	75mm	Carbon fiber
770CT	25.0kg / 55.0lbs	20.0cm~140.0cm / 7.9in~55.1in	65.0cm / 25.6in	2.7kg / 5.9lbs	100mm	Carbon fiber



761AT / 771AT / 761CT / 771CT

▶ 761AT/771AT

-  75mm/100mm
-  Aluminum
-  4



▶ 761CT/771CT

-  75mm/100mm
-  Carbon fiber
-  4



RECOMMENDED ACCESSORIES









Stone bag
ST-1



Dolly
E17004C

SPECIFICATIONS



Model						
761AT	20.0kg / 44.0lbs	13.0cm~170.0cm / 5.1in~66.9in	64.0cm / 25.2in	2.9kg / 6.5lbs	75mm	Aluminum
771AT	25.0kg / 55.0lbs	20.0cm~180.0cm / 7.9in~70.9in	69.0cm / 27.2in	3.5kg / 7.7lbs	100mm	Aluminum
761CT	20.0kg / 44.0lbs	13.0cm~170.0cm / 5.1in~66.9in	64.0cm / 25.2in	2.2kg / 4.9lbs	75mm	Carbon fiber
771CT	25.0kg / 55.0lbs	20.0cm~180.0cm / 7.9in~70.9in	69.0cm / 27.2in	3.1kg / 6.8lbs	100mm	Carbon fiber

ACCESSORIES
▶ Pages 47-54



SYSTEMS
▶ Pages 27-46

EI7500 / EI7501 / EI7502



▶ EI7500

-  75/100mm
-  Aluminum
-  1

▶ EI7501

-  75/100mm
-  Aluminum
-  2

▶ EI7502

-  75/100mm
-  Aluminum
-  2



SPECIFICATIONS

EI7500

 Payload	50.0kg / 110.0lbs	 Bowl size	75 / 100mm
 Height range	15.0cm~15.0cm / 6.1in~6.1in	 Net weight	2.4kg / 5.3lbs
 Transport length	15.0cm / 6.1in	 Material	Aluminum

EI7501



 Payload	50.0kg / 110.0lbs	 Bowl size	75 / 100mm
 Height range	23.0cm~48.5cm / 9.1in~19.1in	 Net weight	3.8kg / 8.4lbs
 Transport length	37.0cm / 14.6in	 Material	Aluminum

EI7502



 Payload	50.0kg / 110.0lbs	 Bowl size	75 / 100mm
 Height range	38.0cm~70.0cm / 15.0in~27.6in	 Net weight	4.0kg / 8.8lbs
 Transport length	47.0cm / 18.5in	 Material	Aluminum

ECT150XS / EAT150S / EAT150M / EAT150



▶ ECT150XS

-  150mm
-  Carbon fiber
-  1



▶ EAT150S

-  150mm
-  Aluminum
-  2

▶ EAT150M

-  150mm
-  Aluminum
-  2

▶ EAT150

-  150mm
-  Aluminum
-  2



SPECIFICATIONS





ECT150XS

 Payload	100.0kg / 220.0lbs	 Bowl size	150mm
 Height range	22.0cm~22.0cm / 48.5in~48.5in	 Net weight	4.2kg / 9.2lbs
 Transport length	22.0cm / 48.5in	 Material	Carbon fiber

EAT150S

 Payload	100.0kg / 220.0lbs	 Bowl size	150mm
 Height range	26.5cm~43.0cm / 10.4in~16.9in	 Net weight	5.6kg / 12.3lbs
 Transport length	36.5cm / 14.4in	 Material	Aluminum

EAT150M

 Payload	100.0kg / 220.0lbs	 Bowl size	150mm
 Height range	55.0cm~93.0cm / 21.7in~36.6in	 Net weight	6.6kg / 14.6lbs
 Transport length	60cm / 23.6in	 Material	Aluminum

EAT150

 Payload	100.0kg / 220.0lbs	 Bowl size	150mm
 Height range	78.0cm~156.0cm / 30.7in~61.4in	 Net weight	9.5kg / 20.9lbs
 Transport length	92.5cm / 36.4in	 Material	Aluminum

E-IMAGE Head & Tripod System

E-IMAGE SYSTEMS are suitable for various of video and integrative camcorder. In accordance with different requirements, they can be used for News and Film taking. Innovative design and special appearance can give you a glimpse unforgettable figure and sheen will make you feel its unique charm as like customized for your professionally.



EG03AA / EG03A2 / EG05A2



SPECIFICATIONS

EG03AA	Fluid head	GH03	Payload 5.0kg / 11.0lbs Height range 77.5cm~160.5cm / 30.5in~63.2in Transport length 81.5cm / 32.1in Net weight 4.9kg / 10.8lbs
	Tripod	AT7402A	
	Spreader	Fixed middle spreader	
	Bag	SC-1	

EG03A2	Fluid head	GH03	Payload 5.0kg / 11.0lbs Height range 75.0cm~168.5cm / 29.5in~66.5in Transport length 83.5cm / 32.9in Net weight 4.9kg / 10.8lbs
	Tripod	GA752	
	Spreader	GS01 middle spreader	
	Bag	SC-1	

EG05A2	Fluid head	GH05	Payload 8.0kg / 17.6lbs Height range 76.0cm~169.5cm / 29.9in~66.7in Transport length 84.5cm / 33.3in Net weight 5.4kg / 11.8lbs
	Tripod	GA752	
	Spreader	GS01 middle spreader	
	Bag	SC-1	

EG03A3



Flat base fluid head can be used on the sliders



Sliders can be used on the tripod with flat adapter directly

SPECIFICATIONS

EG03A3	Fluid head	GH03F	Payload 5.0kg / 11.0lbs Height range 76.5cm~170.0cm / 30.1in~66.9in Transport length 85.0cm / 33.5in Net weight 5kg / 11.0lbs
	Adapter	75BF	
	Tripod	GA752	
	Spreader	GS01 middle spreader	
	Bag	SC-1	

EG04AS

NEW

▶ EG04AS

 4.1kg



LIGHTER WEIGHT
Only **4.1kg**



Dual-base head with a 75mm ball base and flat base

EG06A / EG06A2 / EG06C2

▶ EG06A

▶ EG06A2

▶ EG06C2



KIT

SPECIFICATIONS

EG04AS	Fluid head	GH04	 Payload	6.0kg / 13.2lbs
	Tripod	GA752S	 Height range	77.5cm~169.5cm / 30.5in~66.7in
	Spreader	GS01 middle spreader	 Transport length	87.5cm / 34.4in
	Bag	SC-1	 Net weight	4.1kg / 9.0lbs

SPECIFICATIONS

EG06A	Fluid head	GH06	 Payload	6.0kg / 13.2lbs
	Tripod	GA751	 Height range	90.0cm~152.5cm / 35.4in~60.0in
	Spreader	GS01 middle spreader	 Transport length	97.0cm / 38.2in
	Bag	SC-2	 Net weight	5.0kg / 10.9lbs

EG06A2	Fluid head	GH06	 Payload	6.0kg / 13.2lbs
	Tripod	GA752	 Height range	77.5cm~171.0cm / 30.5in~67.3in
	Spreader	GS01 middle spreader	 Transport length	86.0cm / 33.9in
	Bag	SC-1	 Net weight	5.6kg / 12.3lbs

EG06C2	Fluid head	GH06	 Payload	6.0kg / 13.2lbs
	Tripod	GC752	 Height range	77.5cm~171.0cm / 30.5in~67.3in
	Spreader	GS01 middle spreader	 Transport length	86.0cm / 33.9in
	Bag	SC-1	 Net weight	5.2kg / 11.5lbs

EG08A2 / EG08C2 / EG10A2 / EG10C2



▶ EG08A2
▶ EG08C2

▶ EG10A2
▶ EG10C2

EG08A2L / EG08C2L / EG10A2L / EG10C2L



▶ EG08A2L
▶ EG08C2L

▶ EG10A2L
▶ EG10C2L

KIT

SPECIFICATIONS

EG08A2	Fluid head	GH08	Payload 8.0kg / 17.6lbs Height range 76.0cm~169.5cm / 29.9in~66.7in Transport length 84.5cm / 33.3in Net weight 5.5kg / 12.1lbs
	Tripod	GA752	
	Spreader	GS01 middle spreader	
	Bag	T10	
EG08C2	Fluid head	GH08	Payload 8.0kg / 17.6lbs Height range 76.0cm~169.5cm / 29.9in~66.7in Transport length 84.5cm / 33.3in Net weight 5.1kg / 11.2lbs
	Tripod	GC752	
	Spreader	GS01 middle spreader	
	Bag	T10	
EG10A2	Fluid head	GH10	Payload 10.0kg / 22.0lbs Height range 77.5m~171.0cm / 30.5in~67.3in Transport length 86.0cm / 33.9in Net weight 5.7kg / 12.6lbs
	Tripod	GA752	
	Spreader	GS01 middle spreader	
	Bag	T10	
EG10C2	Fluid head	GH10	Payload 10.0kg / 22.0lbs Height range 77.5m~171.0cm / 30.5in~67.3in Transport length 86.0cm / 33.9in Net weight 5.3kg / 11.7lbs
	Tripod	GC752	
	Spreader	GS01 middle spreader	
	Bag	T10	

SPECIFICATIONS

EG08A2L	Fluid head	GH08L	Payload 8.0kg / 17.6lbs Height range 59.5cm~172.5cm / 23.4in~67.9in Transport length 86.5cm / 34.1in Net weight 7.3kg / 16.1lbs
	Tripod	GA102	
	Spreader	GS02 ground spreader	
	Bag	T20	
EG08C2L	Fluid head	GH08L	Payload 8.0kg / 17.6lbs Height range 59.5cm~172.5cm / 23.4in~67.9in Transport length 86.5cm / 34.1in Net weight 6.3kg / 13.9lbs
	Tripod	GC102	
	Spreader	GS02 ground spreader	
	Bag	T20	
EG10A2L	Fluid head	GH10L	Payload 10.0kg / 22.0lbs Height range 60.5cm~173.5cm / 23.8in~68.3in Transport length 87.5cm / 34.4in Net weight 7.5kg / 16.5lbs
	Tripod	GA102	
	Spreader	GS02 ground spreader	
	Bag	T20	
EG10C2L	Fluid head	GH10L	Payload 10.0kg / 22.0lbs Height range 60.5cm~173.5cm / 23.8in~68.3in Transport length 87.5cm / 34.4in Net weight 6.9kg / 15.2lbs
	Tripod	GC102	
	Spreader	GS02 ground spreader	
	Bag	T20	

EG15A / EG15C / EG15A2 / EG15C2



▶ EG15A
▶ EG15C

▶ EG15A2
▶ EG15C2

SPECIFICATIONS

EG15A	Fluid head	GH15	Payload 15.0kg / 33.0lbs Height range 81.0cm~158.0cm / 31.9in~62.2in Transport length 102.5cm / 40.4in Net weight 8.3kg / 18.2lbs
	Tripod	GA101	
	Spreader	GS02 ground spreader	
	Bag	T30	
EG15C	Fluid head	GH15	Payload 15.0kg / 33.0lbs Height range 81.0cm~158.0cm / 31.9in~62.2in Transport length 102.5cm / 40.4in Net weight 7.7kg / 16.8lbs
	Tripod	GC101	
	Spreader	GS02 ground spreader	
	Bag	T30	
EG15A2	Fluid head	GH15	Payload 15.0kg / 33.0lbs Height range 64.5cm~177.5cm / 25.4in~69.9in Transport length 91.5cm / 36.0in Net weight 8.9kg / 19.6lbs
	Tripod	GA102	
	Spreader	GS02 ground spreader	
	Bag	T20	
EG15C2	Fluid head	GH15	Payload 15.0kg / 33.0lbs Height range 64.5cm~177.5cm / 25.4in~69.9in Transport length 91.5cm / 36.0in Net weight 8.2kg / 18.0lbs
	Tripod	GC102	
	Spreader	GS02 ground spreader	
	Bag	T20	

EG25C / EG25C PLUS



▶ EG25C

NEW
▶ EG25C PLUS

SPECIFICATIONS

EG25C	Fluid head	GH25	Payload 25.0kg / 55.0lbs Height range 80.0cm~157.0cm / 31.5in~61.8in Transport length 101.5cm / 40.0in Net weight 8.1kg / 17.9lbs
	Tripod	GC101	
	Spreader	GS02 ground spreader	
	Bag	T30	
EG25C PLUS	Fluid head	GH25	Payload 25.0kg / 55.0lbs Height range 92.0cm~168.0cm / 36.2in~66.1in Transport length 109.0cm / 42.9in Net weight 12.3kg / 27.1lbs
	Tripod	ECT100L	
	Spreader	Middle spreader	
	Bag	SC-4	

EG20A / EG25A2 / EG25C2



SPECIFICATIONS

EG20A	Fluid head	GH20	Payload 20.0kg / 44.0lbs Height range 79.0cm~156.0cm / 31.1in~61.4in Transport length 100.5cm / 39.6in Net weight 8.4kg / 18.5lbs
	Tripod	GA101	
	Spreader	GS02 ground spreader	
	Bag	T30	
EG25A2	Fluid head	GH25	Payload 25.0kg / 55.0lbs Height range 62.5cm~175.5cm / 24.6in~69.1in Transport length 89.5cm / 35.2in Net weight 9.3kg / 20.5lbs
	Tripod	GA102	
	Spreader	GS02 ground spreader	
	Bag	T20	
EG25C2	Fluid head	GH25	Payload 25.0kg / 55.0lbs Height range 62.5cm~175.5cm / 24.6in~69.1in Transport length 89.5cm / 35.2in Net weight 8.6kg / 19.0lbs
	Tripod	GC102	
	Spreader	GS02 ground spreader	
	Bag	T20	

EG40 PLUS



SPECIFICATIONS

EG40 PLUS	Fluid head	GH40 PLUS	Payload 40.0kg / 88.0lbs Height range 100.5cm~178.5cm / 39.6in~70.3in Transport length 115.5cm / 45.5in Net weight 18.3kg / 40.3lbs
	Tripod	EAT150	
	Spreader	EI-7000L middle spreader	
	Bag	Tripod SC-4 / Head S10	

EI7050AA / EI7060AA / EI7060A2



EI7080AA / EI7083AA / EI7083A2



KIT

SPECIFICATIONS

EI7050AA	Fluid head	EI7050H	Payload 5.0kg / 11.0lbs Height range 77.5cm~149.5cm / 30.5in~70.7in Transport length 81.5cm / 32.1in Net weight 4.8kg / 10.6lbs
	Tripod	AT7402B	
	Spreader	Fixed middle spreader	
	Bag	SC-1	

EI7060AA	Fluid head	EI7060H	Payload 8.0kg / 17.6lbs Height range 79.0cm~162.0cm / 31.1in~63.8in Transport length 83.0cm / 32.7in Net weight 5.4kg / 11.9lbs
	Tripod	AT7402A	
	Spreader	Fixed middle spreader	
	Bag	SC-1	

EI7060A2	Fluid head	EI7060H	Payload 8.0kg / 17.6lbs Height range 76.5cm~170.0cm / 30.1in~67.0in Transport length 85.0cm / 33.5in Net weight 5.4kg / 11.8lbs
	Tripod	GA752	
	Spreader	GS01 middle spreader	
	Bag	SC-1	

SPECIFICATIONS

EI7080AA	Fluid head	EI7080H	Payload 12.0kg / 26.4lbs Height range 54.5cm~169.5cm / 21.5in~66.7in Transport length 86.5cm / 34.1in Net weight 6.8kg / 15.0lbs
	Tripod	AT7602A	
	Spreader	GS02 ground spreader	
	Bag	T20	

EI7083AA	Fluid head	EI7083H	Payload 12.0kg / 26.4lbs Height range 55.5cm~170.5cm / 21.9in~67.1in Transport length 87.5cm / 34.4in Net weight 7.1kg / 15.7lbs
	Tripod	AT7602A	
	Spreader	GS02 ground spreader	
	Bag	T20	

EI7083A2	Fluid head	EI7083H	Payload 12.0kg / 26.4lbs Height range 62.5cm~175.5cm / 24.6in~69.1in Transport length 88.5cm / 34.8in Net weight 8.0kg / 17.6lbs
	Tripod	GA102	
	Spreader	GS02 ground spreader	
	Bag	T20	

GH03+760AT / GH08+761CT

▶ GH03+760AT



▶ GH08+761CT



GH08L+770AT / GH10L+771CT

▶ GH08L+770AT



▶ GH10L+771CT



KIT

SPECIFICATIONS

GH03+760AT	Fluid head	GH03	Payload 5.0kg / 11.0lbs Height range 24.5cm~141.5cm / 9.6in~55.7in Transport length 71.5cm / 28.1in Net weight 3.9kg / 8.6lbs
	Tripod	760AT	
	Spreader	/	
	Bag	SC-1	

GH08+761CT	Fluid head	GH08	Payload 8.0kg / 17.6lbs Height range 25.5cm~182.5cm / 10.0in~71.9in Transport length 66.5m / 26.2in Net weight 4.2kg / 9.3lbs
	Tripod	761CT	
	Spreader	/	
	Bag	T10	

SPECIFICATIONS

GH08L+770AT	Fluid head	GH08L	Payload 8.0kg / 17.6lbs Height range 32.5cm~162.5cm / 12.8in~64.0in Transport length 67.5cm / 26.6in Net weight 5.5kg / 12.1lbs
	Tripod	770AT	
	Spreader	/	
	Bag	T10	

GH10L+771CT	Fluid head	GH10L	Payload 10.0kg / 22.0lbs Height range 33.5cm~193.5cm / 13.2in~76.2in Transport length 82.5cm / 32.5in Net weight 5.6kg / 12.3lbs
	Tripod	771CT	
	Spreader	/	
	Bag	T10	

EP880S

▶ EP880S



Pneumatic column pedestal system



Air-pressure in the pneumatic column can be adjusted



Ergonomic hand wheel



Double-wheel 125mm casters with adjustable cable guards



Multi-adjustment(0-8)counterbalance can reach perfect balance quickly and easily



EP880SK

▶ EP880SK



Pneumatic column pedestal system



Air-pressure in the pneumatic column can be adjusted



Fluid head with 100mm ball



Double-wheel 125mm casters with adjustable cable guards



Multi-adjustment(0-8)counterbalance can reach perfect balance quickly and easily



SPECIFICATIONS

EP880S	Pedestal	EP880S	Payload 30.0kg / 66.1lbs Height range 86.0cm~165.5cm / 33.9in~65.2in One-shot stroke 38.0cm / 15.0in Net weight 23.9kg / 52.7lbs
	Dolly	EI7007	
	Case	Aluminum case	

SPECIFICATIONS

EP880SK	Fluid head	GH25	Payload 25.0kg / 55.0lbs Height range 102.5cm~182.0cm / 40.4in~71.7in One-shot stroke 38.0cm / 15.0in Net weight 28.5kg / 62.8lbs
	Pedestal	EP880S	
	Dolly	EI7007	
	Case	Aluminum case	

AT7903

▶ AT7903

UPGRADE
VERSION



Pneumatic assist center column

UPGRADE



One key adjusting the height freely (just pull up the button)



Quick locking



Ergonomic hand wheel



(Optional dolly EI-7005B)

SPECIFICATIONS

AT7903	Pedestal	AT7903	Payload	20.0kg/44.0lbs
	Dolly	EI7005	Height range	102.0cm~184.5cm/40.2in~72.6in
	Case	T30	One-shot stroke	32cm / 12.6in
			Net weight	15.8kg/34.8lbs

EI7903A

▶ EI7903A

UPGRADE
VERSION



Pneumatic assist center column

UPGRADE



One key adjusting the height freely (just pull up the button)



Quick locking



Ergonomic hand wheel



(Optional dolly EI-7005B)

SPECIFICATIONS

EI7903A	Fluid head	EI7103H	Payload	15.0kg/33.0lbs
	Tripod	AT7903	Height range	120.0cm~202.5cm/47.2in~79.7in
	Dolly	EI7005	One-shot stroke	32cm/12.6in
	Case	T30	Net weight	19.9kg/43.9lbs

Plates



(Interchangeable with Manfrotto and Sachtler FSB8,6,4 & ACE plates)

GP1 Video camera plate for head GH03,GH03F,GH05,GH06,706H series, GH08,GH08L,GH10,GH10L

📏 120x50x12mm / 4.7x2.0x0.5in 📖 110g / 0.2lbs



GP2 Video camera plate for head GH15 and GH25

📏 160x70x13mm / 6.3x2.8x0.51in 📖 175g / 0.4lbs



P2 Video camera plate for head 708H series

📏 167x57x10mm / 6.6x2.2x0.4in 📖 170g / 0.4lbs



P3 Video camera plate for head 710H series and GH20

📏 210x70x10mm / 8.3x2.8x0.4in 📖 260g / 0.6lbs



P5 Video camera plate for head 7050H series

📏 57x40x6mm / 2.7x1.6x0.3in 📖 50g / 0.1lbs



(Interchangeable with Manfrotto and Sachtler FSB8,6,4 & ACE plates)

P6 Video quick release adapter

📏 120x100x25mm / 4.7x4.0x1.0in 📖 305g / 0.7lbs



P7 Adapter with long plate

📏 167x100x20mm / 6.6x4.0x0.8in 📖 345g / 0.8lbs



(Interchangeable with Manfrotto and Sachtler FSB8,6,4 & ACE heads)

P8 Long plate for head GH03,GH03F,GH06,GH08,GH08L,GH10,GH10L

📏 360x50x12mm / 14.2x2.0x0.5in 📖 295g / 0.7lbs



(Interchangeable with Manfrotto and Sachtler FSB8,6,4 & ACE heads)

P9 Long plate for head GH03,GH03F,GH06,GH08,GH08L,GH10,GH10L

📏 220x50x12mm / 8.7x2.0x0.5in 📖 195g / 0.4lbs



P10 Video camera plate for head EI7159H series

📏 237x88x13mm / 9.3x3.5x0.5in 📖 405g/0.9lbs

Pan Bars



GB1 Fixed pan bar for GH03,GH03F heads

📏 385mm / 15.2in 📖 205g / 0.5lbs



HD-7050 Fixed pan bar for the EI7050H video head

📏 385mm / 15.2in 📖 195g / 0.4lbs



GB2 Telescopic pan bar for GH06,GH08,GH10 heads

📏 380mm~595mm / 15.0in~23.4in 📖 280g / 0.6lbs



HD-7060 Telescopic pan bar for the EI706H series video head

📏 380mm~595mm / 15.0in~23.4in 📖 255g / 0.6lbs

GB3 Telescopic pan bar for GH08L,GH10L,GH15,GH25 heads

📏 405mm~605mm / 15.9in~23.8in 📖 385g / 0.8lbs

HD-7081 Telescopic pan bar for the EI708H and EI710H series video head

📏 410mm~610mm / 16.1in~24.1in 📖 355g / 0.8lbs



HD-7159 Telescopic pan bar for the EI7159H video head

📏 395mm~595mm / 15.6in~23.4in 📖 410g / 0.9lbs

Spreaders



GS01 Middle spreader for GA751,GC751,GA752S,GA752,GC752,GA101,GC101,GA102,GC102,AT7602A

Length range: 200mm~310mm / 7.9in~12.2in
 Weight: 250g / 0.6lbs



EI-7000L Middle spreader for EAT150

Length range: 260mm~520mm / 10.2in~20.5in
 Weight: 1560g / 3.4lbs



GS02 Ground spreader for GA751,GC751,GA752S,GA752,GC752,GA101,GC101,GA102,GC102,AT7602A

Length range: 870mm~1310mm / 34.3in~51.6in
 Weight: 840g / 1.9lbs



EI-7001S Ground spreader for EI7501/EI7502/EAT150S/EAT150M

Length range: 270mm~360mm / 10.6in~14.2in
 Weight: 600g / 1.3lbs

Rubber Feet



F3S Rubber feet for GA752S tripod



F3 Rubber feet for all the E-Image video tripods

Dollies



EI-7003 Basic dolly

Designed for light and medium weight tripods. The 76mm/3 inch wheels have a sure-lock feature and can be individually braked. Folds for transporting.

Weight: 3.5kg / 7.7lbs
 Height: 100cm / 39.4in
 Capacity: 40kg / 88.2lbs



EI-7004 Medium dolly

Designed for medium weight tripods. The 100mm/4 inch wheels have a sure-lock feature and can be individually braked. Folds for transporting.

Weight: 3.2kg / 7.0lbs
 Height: 100cm / 39.4in
 Capacity: 60kg / 132.3lbs



EI-7004B Medium dolly

Designed for medium weight tripods. The 100mm/4 inch wheels have a sure-lock feature and can be individually braked. It comes with cable guard. Folds for transporting.

Weight: 3.4kg / 7.5lbs
 Height: 100cm / 39.4in
 Capacity: 60kg / 132.3lbs



Dollies



NEW



EI-7004C is a professional universal tripod dolly, which comes with fully adjustable leg locks to fit almost all full-sized tripods.

EI-7004C Universal dolly

It comes with fully adjustable leg locks to fit almost all full-size tripods, not only the horseshoe feet but also the nail feet and rubber feet. It features on-step easy lock, locking wheels to secure the tripod. Folds to a compact 18" for storage and transport.

3.6kg / 7.9lbs 100cm / 39.4in 60kg / 132.3lbs



EI-7005 Video dolly

Super sturdy, designed for heavy duty systems. The 100mm/4 inch wheels can be individually braked. Folds for transporting.

6.8kg / 15.0lbs 100cm / 39.4in 100kg / 220.5lbs



EI-7005B Video dolly

Super sturdy, designed for heavy duty systems. The 100mm/4 inch wheels can be individually braked. It comes with cable guard. Folds for transporting.

7.0kg / 15.4lbs 100cm / 39.4in 100kg / 220.5lbs



Dollies



EI-7006 Video dolly

Super sturdy, designed for heavy duty systems. The 100mm/4 inch wheels can be individually braked. Includes a 100mm bowl attachment which allows you to attach head for lower angle shooting. Folds for transporting.

7.0kg / 15.4lbs 100cm / 39.4in 100kg / 220.5lbs

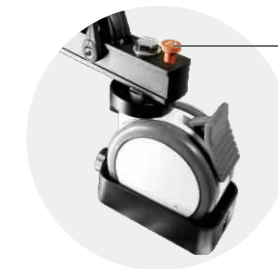

Movement direction can be fixed, such as straight line

EI-7007 Super dolly

Designed for pedestal system and other heavy duty system. The 127mm/5inch wheels with cable guard can be individually braked, also the movement direction can be fixed. Super sturdy. Folds for transporting.

10.7kg / 23.6lbs 100cm / 39.4in 100kg / 220.5lbs

Stone Bag



ST-1 Stone bag

Increase stability of tripods

Tripod Bag



SC-1

89x13x21cm / 35.0x5.1x8.2in 900g / 2.0lbs



Oscar T10

86x13.5x19.5cm / 33.9x5.3x7.7in 2100g / 4.6lbs



SC-2

99x21x15cm / 39.0x8.3x6.0in 1060g / 2.3lbs



Oscar T20

96x16x21cm / 37.8x6.3x8.3in 2400g / 5.3lbs



SC-3

107x21x14.5cm / 42.1x8.3x5.7in 1100g / 2.4lbs



Oscar T30

104x16x21cm / 40.9x6.3x8.3in 2800g / 6.2lbs



Harmony T40

91x25x21cm / 35.8x9.8x8.3in 4700g / 10.4lbs



Harmony T50

101x26x25cm / 39.8x10.2x9.8in 5800g / 12.8lbs

Other Accessories



EI-A17 Bowl adapter 100/75mm convert all E-IMAGE 100mm bowl tripod to 75mm bowl

70g / 0.2lbs



EI-A17S Bowl adapter 100/75mm convert E-IMAGE 770/771/ tripod to 75mm bowl

70g / 0.2lbs



EI-A18 Bowl adapter 150/100mm convert all E-IMAGE 150mm bowl tripod to 100mm bowl

350g / 0.8lbs



EI-A19 100mm bowl riser

690g / 1.5lbs

100mm

100mm



75FS 75mm bowl to flat adapter convert all E-IMAGE 75mm bowl tripods to flat base

100mm / 4.0in

230g / 0.5lbs



75BF 75mm bowl to flat adapter convert all E-IMAGE 75mm bowl tripods to flat base

110mm / 4.3in

215g / 0.5lbs



100BF 100mm bowl to flat adapter convert all E-IMAGE 100mm bowl tripods to flat base

115mm / 4.5in

445g / 1.0lbs



75S

40mm / 1.6in

50g / 0.1lbs



75L

50mm / 2.0in

65g / 0.1lbs























100L

60mm / 2.4in

115g / 0.3lbs

KEY TO SYMBOLS

- | | | | |
|---|----------------------------|---|---------------------|
|  | Net weight |  | Tilt range |
|  | Payload range |  | Temperature range |
|  | Bowl size |  | Counterbalance |
|  | Height range |  | Transport length |
|  | Diameter |  | Grades of tilt drag |
|  | Sections |  | Safety payload |
|  | Material |  | Footprint diameter |
|  | One-shot stroke |  | Flat base height |
|  | Grades of pan drag |  | Max length |
|  | Size (Length/width/height) |  | Length range |

THE NEW
E-IMAGE
WEBSITE

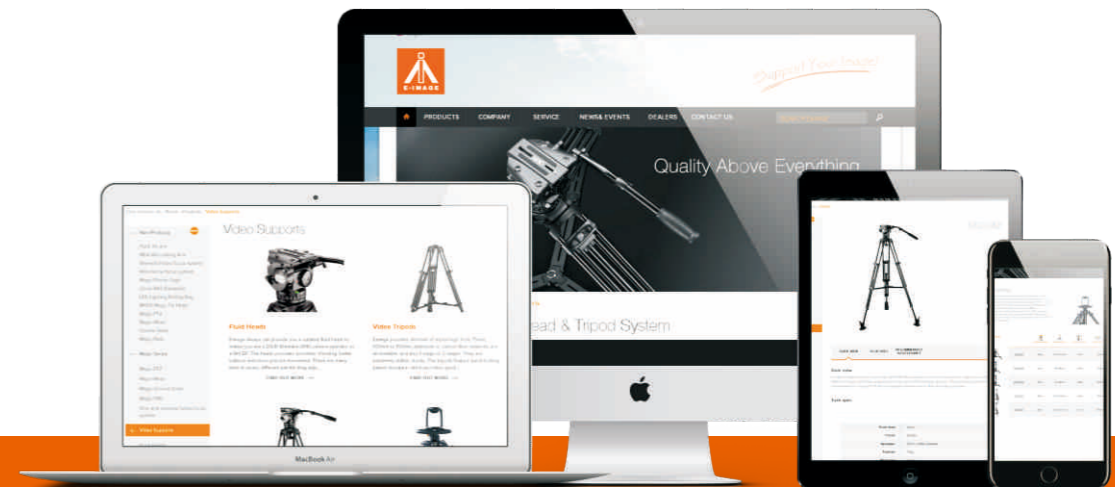

- CONTENTS
- New Products
 - Magic Series
 - Video Supports
 - Tripod Accessories
 - Bags
 - Accessories

www.eimagevideo.com